

Installation Guide

FIREFLY FR Multi-Service Block

Note:

Dimensions of FIREFLY FR Multi-Service Block (FR Block) aperture within the substrate can be:

- 100 mm - 1000 mm wide and up to 100 mm high (one FR Block)
- 100mm - 500 mm wide and up to 200 mm high (two FR Blocks stacked up)

FR Block can be located within:

- the field of the substrate
- in contact with the substrate and the slab above

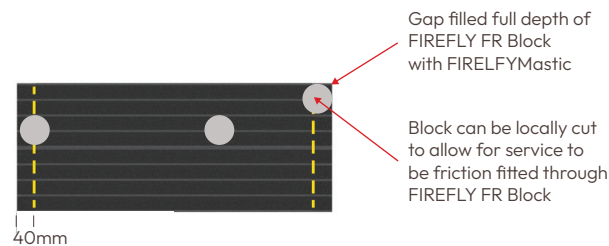

Figure 6 - Penetration allowable zone for SP17 and SP19 in FIREFLY FR Block

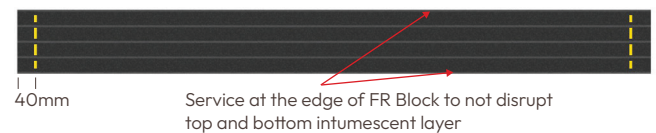

Figure 4 - Penetration allowable zone for FIREFLY FR Block within apertures 1000 mm x 100 mm

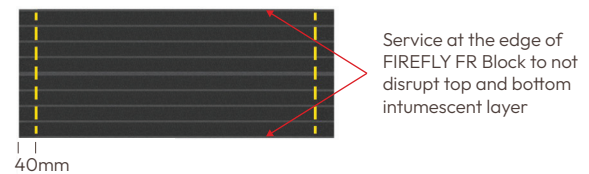

Figure 5 - Penetration allowable zone for FIREFLY FR Block within apertures 500 mm x 200 mm

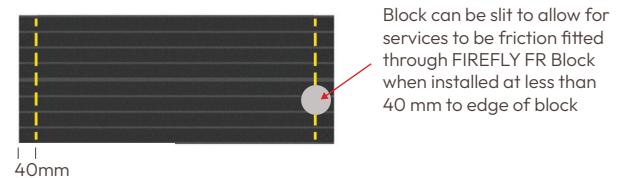

Figure 7 - Penetration allowable zone for services at the edge of FIREFLY FR Block

Part A | Preparing the substrate

- For Speed Panel, refer to S1
- For Fire Rated Plasterboard wall, refer to S2
- For INEX Wallboard, refer to S3
- For Alphapanel wall, refer to S3a
- For Stonewall Platinum FR60 wall, refer to S4a
- For FIREFLYBatt penetration seal, refer to S4b
- For hollow masonry with voids less than 30% of cross section, refer to S6
- For hollow masonry with voids greater than 30% of cross section, refer to S7
- For Brickworks Pronto panel, refer to S8
- For Hebel Power panel, refer to S9
- For Binderholz CLT wall, refer to S10
- For XLAM CLT wall, refer to S11

S1 | Speed Panel Wall

Step 1 Cut a neat hole in the wall as per requirements.

Step 2 Measure the dimensions of the aperture.

Step 3 Speed panel aperture track shall have a 100 mm wide strip of 13 mm standard or fire grade plasterboard on each side of the wall around the aperture. It should be fixed with two rows of 10g x 30 mm long self-drilling screws at 25 mm from the corners and then at 100 mm centres.

Step 4 Fill the gaps between the track and speed panel with FIREFLYMastic or FIREFLYMasticHP.

Refer to Part B for further Instructions.

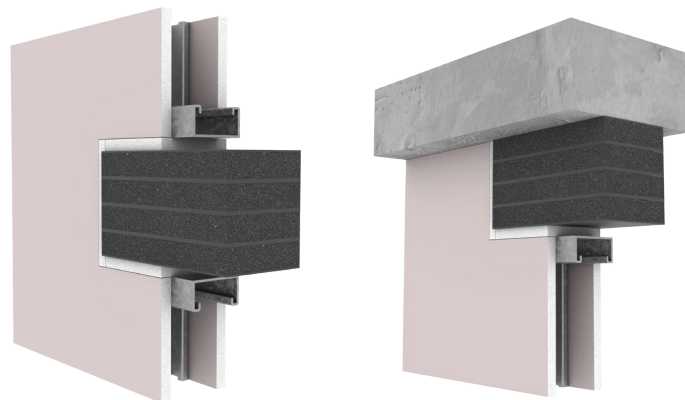
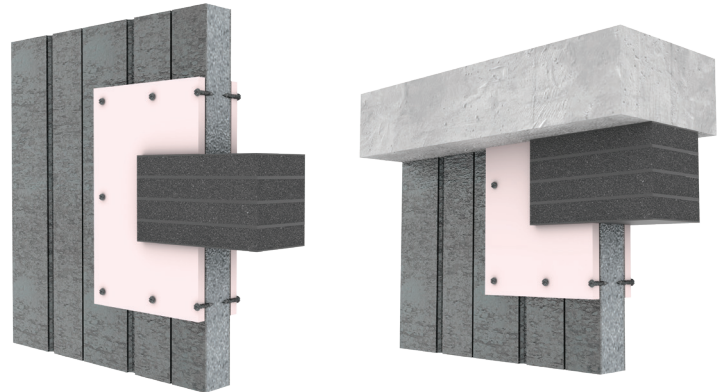

S2 | Fire Rated Plasterboard Wall

Step 1 Cut a neat hole in the wall as per requirements.

Step 2 Frame the aperture within the plasterboard wall with steel tracks or timber noggin, whichever is applicable.

Step 3 For single stud wall with cavity > 76 mm, line the aperture with one layer of fire rated plasterboard.

Step 4 For double stud walls (max 64 mm cavity), line the aperture with one layer of fire rated plasterboard.

Refer to Part B for further Instructions.

S3 | Inex Wallboard

Step 1 Cut a neat hole in the wall as per requirements.

Step 2 Frame the aperture within the plasterboard wall with steel tracks or timber noggin, whichever is applicable.

Step 3 For single stud wall with cavity > 76 mm, line the aperture with one layer of fire rated plasterboard.

Step 4 For double stud walls (max 64 mm cavity), line the aperture with one layer of fire rated plasterboard.

Refer to Part B for further Instructions.

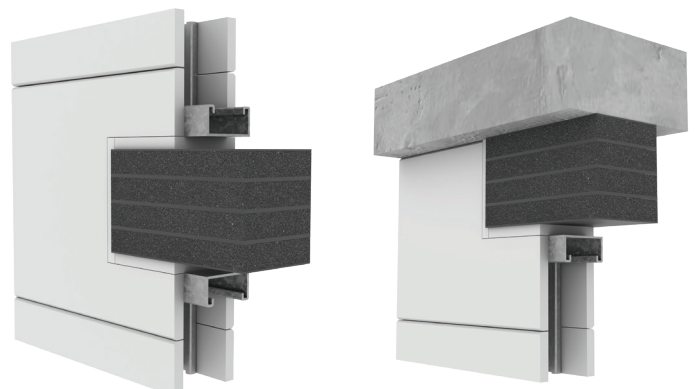

S3a | Alphapanel wall

Step 1 Cut a neat hole in the wall as per requirements.

Step 2 Frame the aperture within the plasterboard wall with steel tracks or timber noggin, whichever is applicable.

Step 3 For single stud wall with cavity > 76 mm, line the aperture with one layer of fire rated plasterboard.

Step 4 For double stud walls (max 64 mm cavity), line the aperture with one layer of fire rated plasterboard.

Refer to Part B for further Instructions.

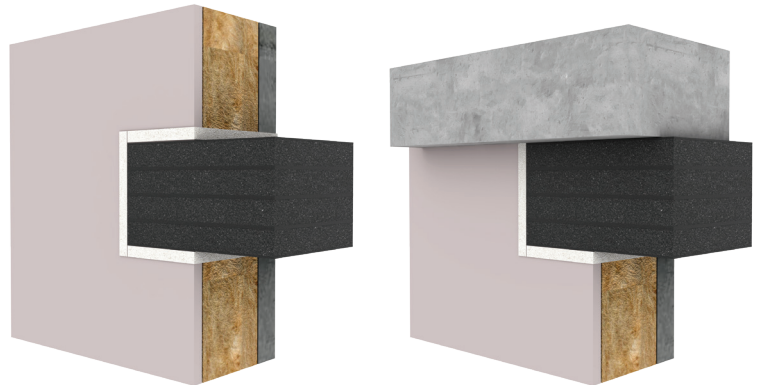

S4a | Stonewall Platinum FR60

Step 1 Cut a neat hole in the wall as per requirements.

Step 2 Measure the dimensions of the aperture.

Step 3 Make a letterbox structure as per dimensions using 1 layer of FIREFLYBatt. The Batt should be glued together on all four sides of the structure using FIREFLYMastic. Moreover, secure the batts with 90mm pigtail screws at the corners (25 mm away from the edges).

Refer to Part B for further Instructions.

S4b | FIREFLYBatt penetration seal

Step 1 Cut a neat hole in the FIREFLYBatt as per requirements.

Step 2 Measure the dimensions of the aperture.

Step 3 Use FIREFLYMastic or FIREFLYMasticHP to fill the gaps of up to 10 mm between the FIREFLYBatt and FR Block, if required.

Refer to Part B for further Instructions.

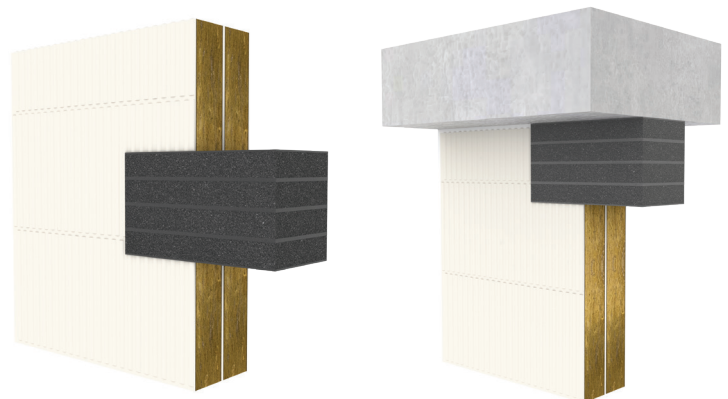

S6 | Solid & Hollow Masonry with voids < 30% of cross section

Step 1 Cut a neat hole in the wall as per requirements.

Step 2 Use FIREFLYMastic or FIREFLYMasticHP to fill the gaps of up to 10 mm between substrate and FR Block, if required.

Step 3 For gaps larger than 10 mm, use FIREFLY-Mortar to fill gaps, if required.

Refer to Part B for further Instructions.

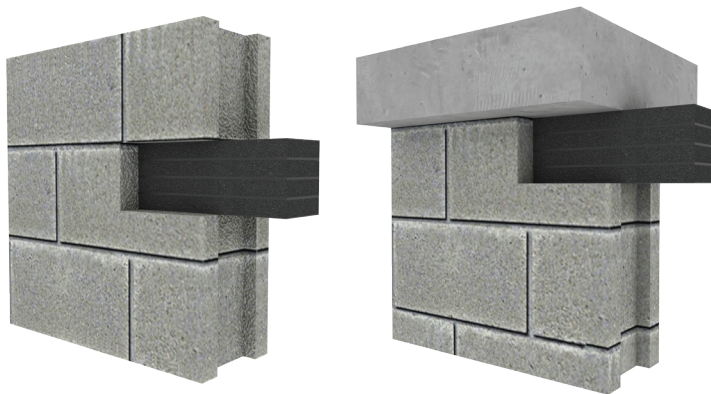

S7 | Solid & Hollow Masonry with voids > 30% of cross section

Step 1 Cut a neat hole in the wall as per requirements.

Step 2 Install steel sheets over the voids above and below in the aperture.

Step 3 Use FIREFLYMastic or FIREFLYMasticHP to fill the gaps of up to 10 mm between substrate and FR Block, if required.

Step 4 For gaps larger than 10 mm, use mortar to fill the gaps, if required.

Refer to Part B for further Instructions.

S8 | Brickworks Pronto Panel

Step 1 Cut a neat hole in the wall as per requirements.

Step 2 Use FIREFLYMastic or FIREFLYMasticHP to fill the gaps of up to 10 mm between substrate and FR Block, if required.

Refer to Part B for further Instructions.

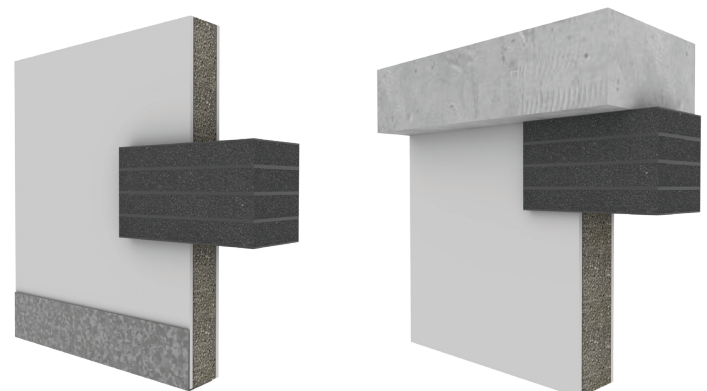

S9 | Hebel Power Panel

Step 1 Cut a neat hole in the wall as per requirements.

Step 2 Use FIREFLYMastic or FIREFLYMasticHP to fill the gaps of up to 10 mm between substrate and FR Block, if required.

Refer to Part B for further Instructions.

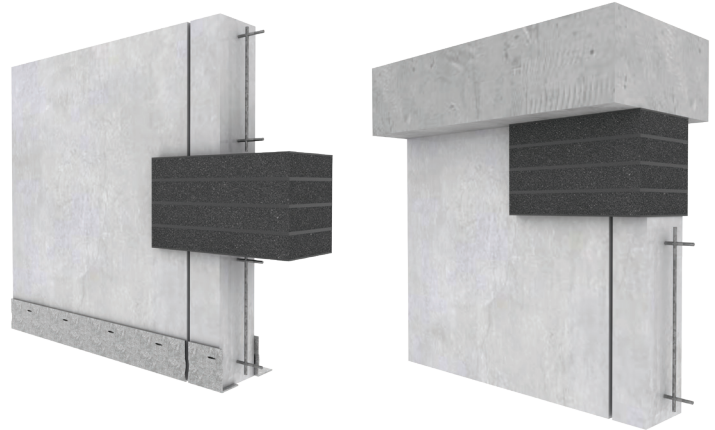

S10 | Binderholz CLT Wall

Step 1 13 mm Knauf Tru-Rock should be present on each side of the CLT wall.

Step 2 Cut a neat hole in the wall as per requirements.

Step 3 Line the CLT aperture with a single layer of 13mm Knauf Tru-Rock.

Step 4 Use FIREFLYMastic HP to fill the gaps of up to 10 mm between the substrate and FR Block, if required.

Step 5 Apply FIREFLYMastic to fill the junctions in the lining.

Refer to Part B for further Instructions.

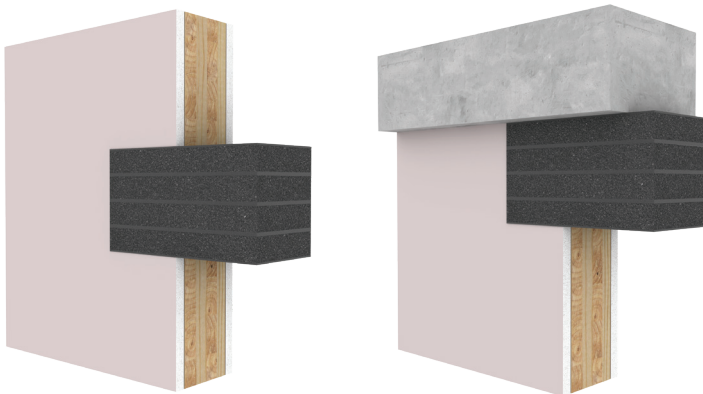

S11 | XLam CLT Wall

Step 1 16 mm Fire Rated Plasterboard should be present on each side of the CLT wall.

Step 2 Cut a neat hole in the wall as per requirements.

Step 3 Use FIREFLYMasticHP to fill the gaps of up to 10 mm between the substrate and FR Block, if required.

Refer to Part B for further Instructions.

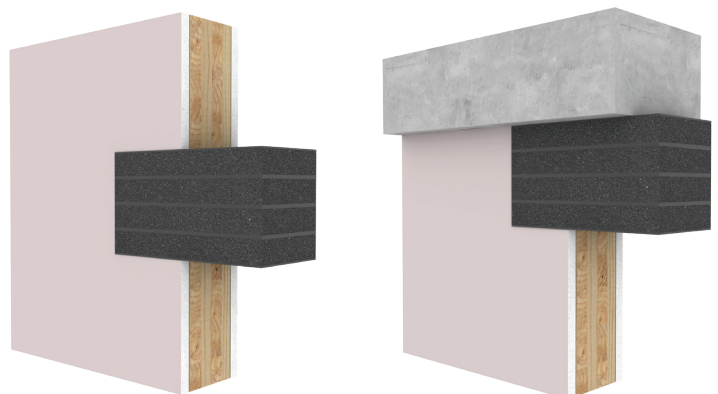

Part B | Prior to installation of services

Step 1

Measure the dimensions of the aperture.

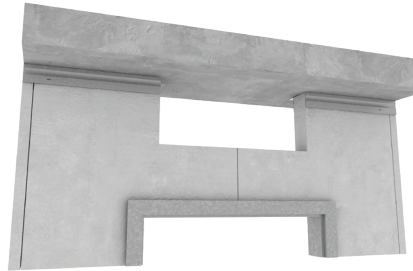
**Step 2**

Cut the FR Block as per the dimensions of the aperture.

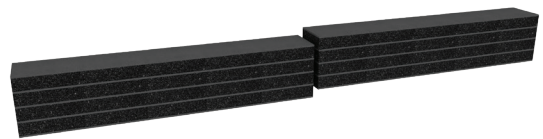
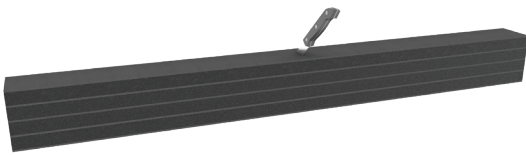
**Step 3**

Run 2 x 6 mm beads of FIREFLYMasticHP around the inside of the aperture, on each side of the wall.

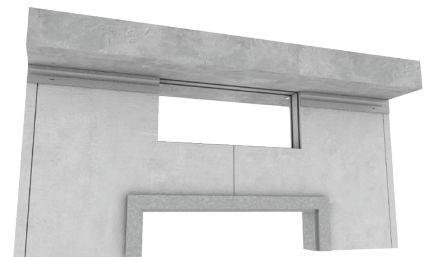
**Step 4**

Place first block of FR Block into the aperture, then apply two beads of FIREFLYMasticHP on the top of the first block.



Step 5

Squeeze the second block and place it into the aperture.

Refer to Part C for installation of services.



Part B | Pre-installed services

If services are installed in the aperture prior to the installation of the FR Block, first mark the approximate location of the services on the FR Block, and cut the FR Block as per **Part C** of this guide to accommodate different services, then complete the steps outlined below.

Step 1

Split the first block of the FR Block into two layers.

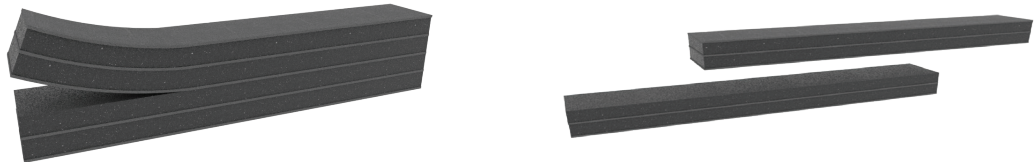

Step 2

Run 2 x 6 mm beads of FIREFLYMasticHP around the inside of the aperture, on each side of the wall.



Step 3

Install the first layer at the bottom of the aperture.



Step 4

Apply a bead of FIREFLYMasticHP on the top of the first layer.

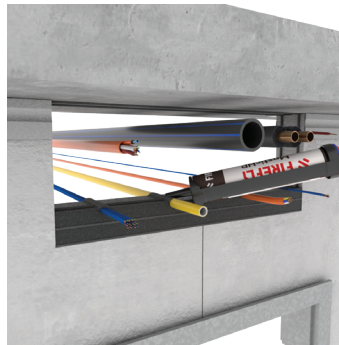

Step 5

Install the second layer of FR Block on top of the first, and apply a bead of FIREFLY-Mastic on top of this, second layer.

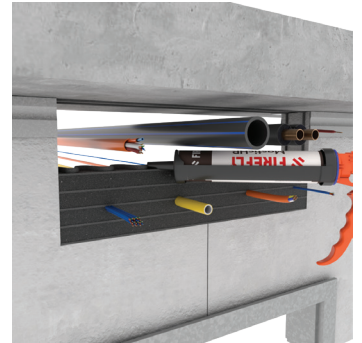

Step 6

Repeat the above steps for the second FR Block until the aperture is sealed off.

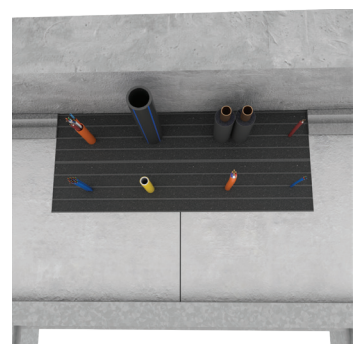
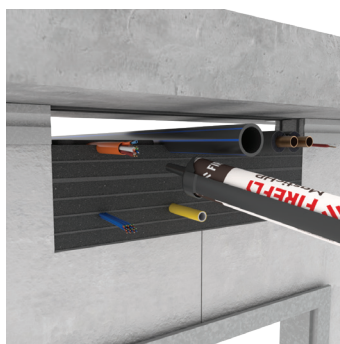
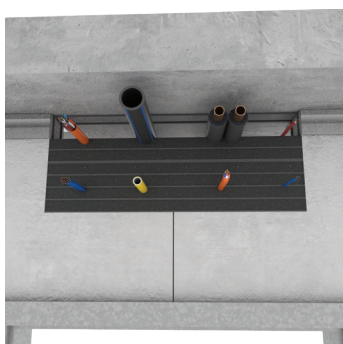

Part C | Installation of services

For Services up to 16 mm

Step 1 For very small services, use a pointy screwdriver to create a hole in the sponge and insert the service; for larger services up to 16 mm, cut a cross in the FR Block sponge using a steak knife.

Step 2 Simply insert the service.

Note: Individual services must be separated by 40 mm. Refer to Part D for local protection of different services.

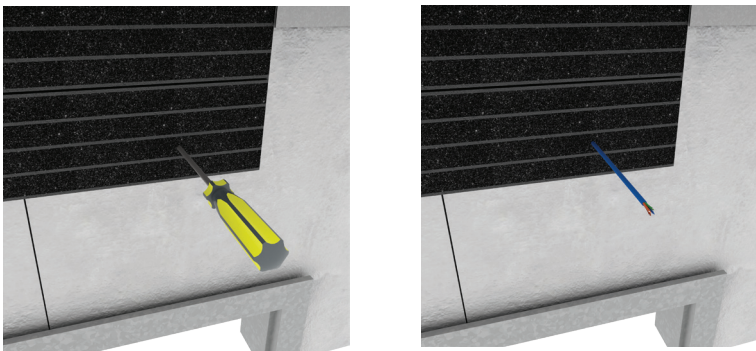

Very small services

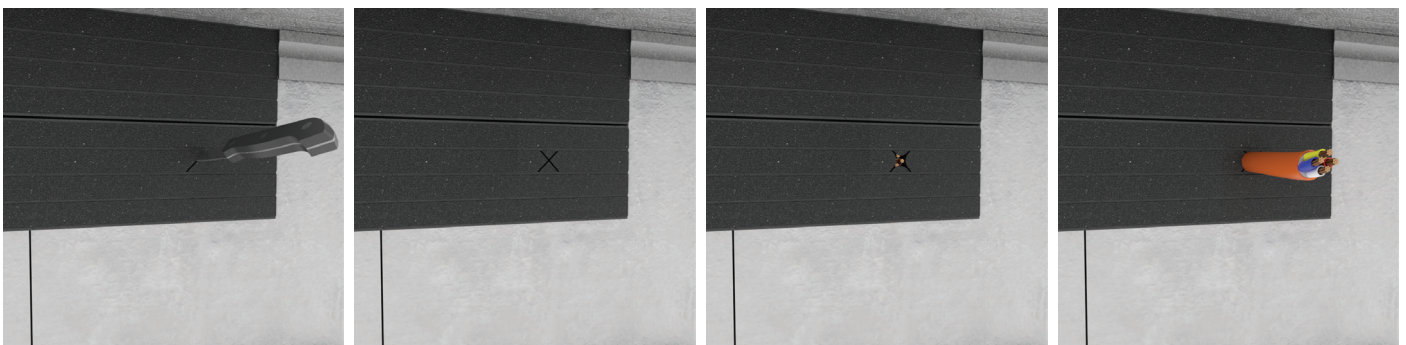

Services up to 16 mm

Services between 16 mm & 40 mm

Step 1 For larger services such as cable bundles, conduits or large pipes, cut the sponge in a rectangular shape using a steak knife or similar knife. **Do not cut the graphite layers.**

Step 2 Place your fingers in the hole and open the graphite layers to cut enough space for the service.

Step 3 Insert the service into the hole

Note: Individual services must be separated by 40 mm. Refer to Part D for local protection of different services.

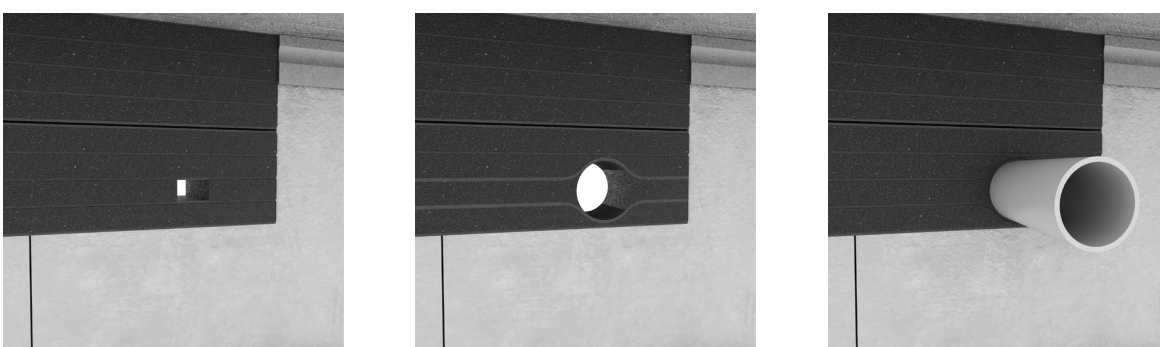

For Services larger than 40 mm

Step 1 Cut the middle layer of graphite only where the service is to be installed.

Step 2 Cut the sponge in a rectangular shape using a steak or similar knife.

Step 3 Place your fingers in the hole and open the graphite layers to cut enough space for the service.

Step 4 Insert the service into the hole

Note: Individual services must be separated by 40 mm. Refer to Part D for local protection of different services.

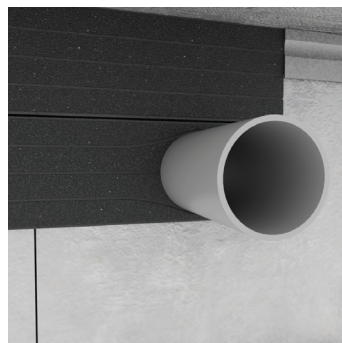
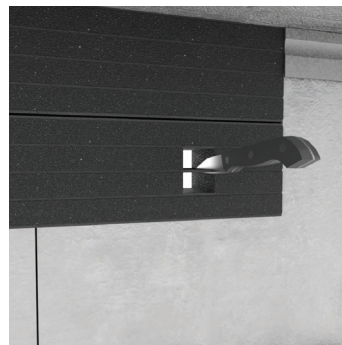

Part D | Service Penetration details, Electrical & Communication

Service ID **SP1**

Service Fire Alarm 2C 2.5 mm² cable bundle, 1 cable

Additional local Protection **Install Method 1, Figures 4 & 5**
None
Install Method 2, Figure 7
When services are located at the edge of the block, FIREFLYMasticHP should be applied to gap between the service and FIREFLY FR Block

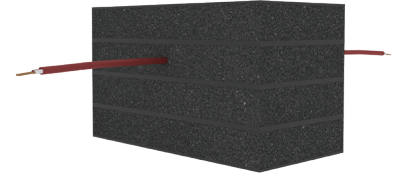

Service ID **SP2**

Service Fire Alarm 2C 2.5 mm² cable bundle, 2 to 6 cables

Additional local Protection **Install Method 1, Figures 4 & 5**
25 mm fillet of FIREFLYMasticHP
Install Method 2, Figure 7
When services are located at the edge of the block, protection required as per described above and with additional FIREFLYMasticHP applied to gap between service and FIREFLY FR Block

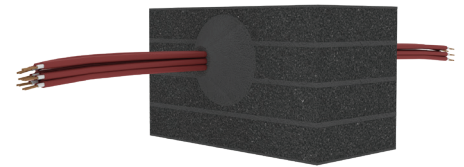

Service ID **SP3**

Service CAT 6 cable bundle, 1 to 6 cables

Additional local Protection **Install Method 1, Figures 4 & 5**
None
Install Method 2, Figure 7
When services are located at the edge of the block, FIREFLYMasticHP should be applied to gap between the service and FIREFLY FR Block

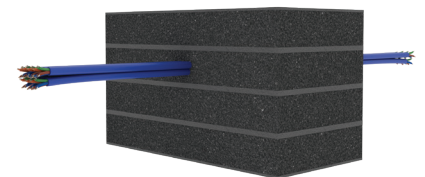

Service ID **SP4**

Service 4C security cable bundle, 1 to 6 cables

Additional local Protection **Install Method 1, Figures 4 & 5**
None
Install Method 2, Figure 7
When services are located at the edge of the block, FIREFLYMasticHP should be applied to gap between the service and FIREFLY FR Block

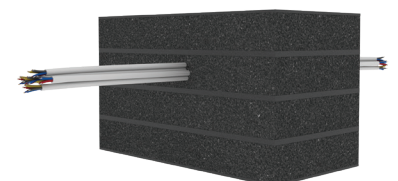

Service ID	SP5
Service	Up to 26 mm PVC conduit with TPS (2.5 mm ² 2C+E) cable bundle, 1 to 6 cables
Additional local Protection	Install Method 1, Figures 4 & 5 25 mm fillet of FIREFLYMasticHP

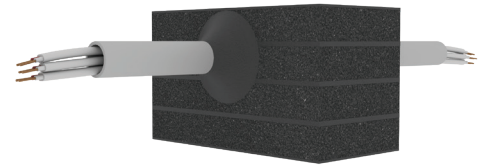

Service ID	SP6
Service	RG6 cable bundle, 1 to 6 cables
Additional local Protection	Install Method 1, Figures 4 & 5 None Install Method 2, Figure 7 When services are located at the edge of the block, FIREFLYMasticHP should be applied to gap between the service and FIREFLY FR Block



Service ID	SP7
Service	5 mm & 10 mm Fibre Optic cable bundle, 1 to 20 cables
Additional local Protection	Install Method 1, Figures 4 & 5 None Install Method 2, Figure 7 When services are located at the edge of the block, FIREFLYMasticHP should be applied to gap between the service and FIREFLY FR Block

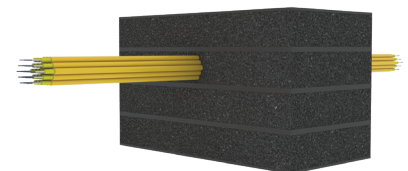

Service ID	SP9
Service	CAT 5 / CAT 5e cable bundle, 1 to 6 cables
Additional local Protection	Install Method 1, Figures 4 & 5 None Install Method 2, Figure 7 When services are located at the edge of the block, FIREFLYMasticHP should be applied to gap between the service and FIREFLY FR Block

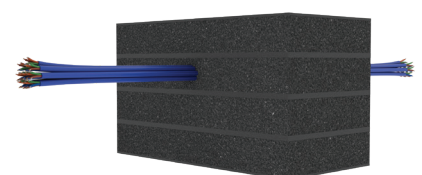

Service ID **SP14**

Service TPS (2.5 mm² 2C+E) single cable

Additional local Protection **Install Method 1, Figures 4 & 5**
None
Install Method 2, Figure 7
When services are located at the edge of the block, FIREFLYMasticHP should be applied to gap between the service and FIREFLY FR Block

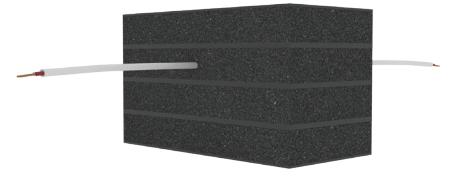

Service ID **SP15**

Service TPS (2.5 mm² 2C+E) cable bundle, 2 to 6 cables

Additional local Protection **Install Method 1, Figures 4 & 5**
25 mm fillet of FIREFLYMasticHP
Install Method 2, Figure 7
When services are located at the edge of the block, protection required as per described above and with additional FIREFLYMasticHP applied to gap between service and FIREFLY FR Block

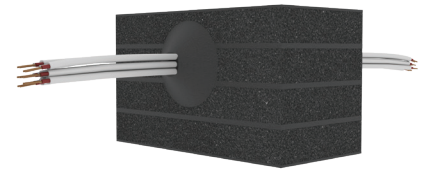

Service ID **SP16**

Service Up to 16 mm Orange mains cable (6 mm² 3C+E, round), 1 cable

Additional local Protection **Install Method 1, Figures 4 & 5**
None
Install Method 2, Figure 7
When services are located at the edge of the block, FIREFLYMasticHP should be applied to gap between the service and FIREFLY FR Block

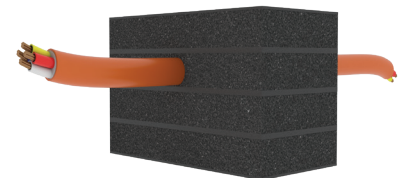

Service ID **SP25**

Service TPS (2.5 mm² 2C+E) single cable and 16 mm Orange mains cable, single cable (6 mm² 3C+E) round

Additional local Protection **Install Method 1, Figures 4 & 5**
25 mm fillet of FIREFLYMasticHP
Install Method 2, Figure 7
When services are located at the edge of the block, protection required as per described above and with additional FIREFLYMasticHP applied to gap between service and FIREFLY FR Block

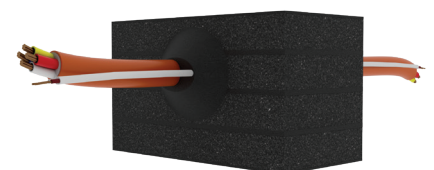

Service ID **SP26**

Service Up to 20 mm “flat” or “round”PVC or XLPE mains power cable (16 mm² 3C+E)

Additional local Protection **Install Method 1, Figures 4 & 5**
25 mm fillet of FIREFLYMasticHP, or
A 100 mm wide FIREFLYPenowrap with 10 mm overlap and fixed into place with 2 x equally spaced stainless steel cable ties.

Install Method 2, Figure 7
When services are located at the edge of the block, protection required as per described above and with additional FIREFLYMasticHP applied to gap between service and FIREFLY FR Block



Service ID **SP27**

Service Up to 26 mm PVC conduit with Cat 6 cable bundle, 1 to 6 cables

Additional local Protection **Install Method 1, Figures 4 & 5**
25 mm fillet of FIREFLYMasticHP

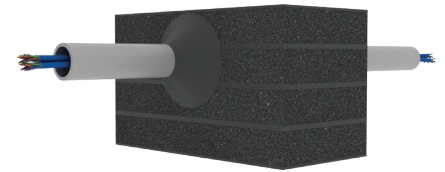

Service ID **SP28**

Service Up to 26 mm PVC conduit with CAT 5 / CAT 5e cable bundle, 1 to 6 cables

Additional local Protection **Install Method 1, Figures 4 & 5**
25 mm fillet of FIREFLYMasticHP

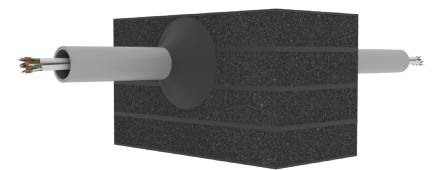

Service ID **SP29**

Service Up to 26 mm PVC conduit with 5 mm & 10 mm Fibre Optic cable bundle, 1 to 20 cables

Additional local Protection **Install Method 1, Figures 4 & 5**
25 mm fillet of FIREFLYMasticHP

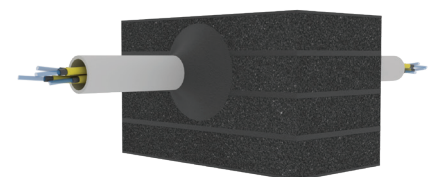

Service ID **SP30**

Service Any combination of SP2, SP3, SP4, SP6, SP7, SP9. 1 to 6 cables

Additional local Protection **Install Method 1, Figures 4 & 5**
25 mm fillet of FIREFLYMasticHP
Install Method 2, Figure 7
When services are located at the edge of the block, protection required as per described above and with additional FIREFLYMasticHP applied to gap between service and FIREFLY FR Block

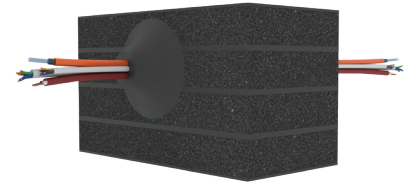

Service ID **SP31**

Service Any combination of SP6, SP7, SP9. 1 to 6 cables

Additional local Protection **Install Method 1, Figures 4 & 5**
None
Install Method 2, Figure 7
When services are located at the edge of the block, FIREFLYMasticHP should be applied to gap between the service and FIREFLY FR Block

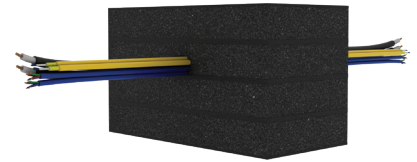

Service ID **SP32**

Service Any combination of SP3, SP6, SP7, SP9. 1 to 5 cables

Additional local Protection **Install Method 1, Figures 4 & 5**
None
Install Method 2, Figure 7
When services are located at the edge of the block, FIREFLYMasticHP should be applied to gap between the service and FIREFLY FR Block

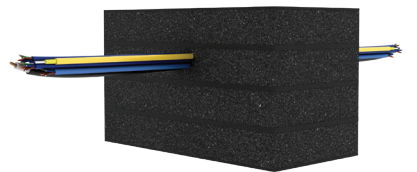

Service ID **SP33**

Service Any combination of SP3, SP4, SP6, SP7, SP9. 1 to 4 cables

Additional local Protection **Install Method 1, Figures 4 & 5**
None
Install Method 2, Figure 7
When services are located at the edge of the block, FIREFLYMasticHP should be applied to gap between the service and FIREFLY FR Block

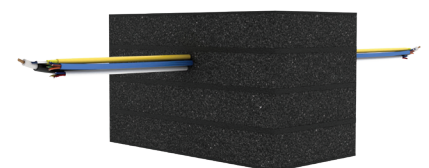

Service ID **SP35**

Service Alarm cables 2C 1.5 mm², 1 to 6 cables

Additional local Protection **Install Method 1, Figures 4 & 5**
FIREFLYMasticHP applied to the gap between service and FIREFLY FR Block.
Install Method 2, Figure 7
When services are located at the edge of the block, protection required as per described above and with additional FIREFLYMasticHP applied to gap between service and FIREFLY FR Block

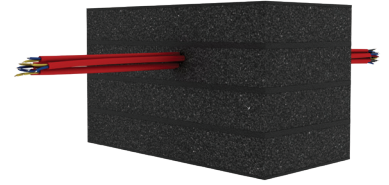

Service ID **SP36**

Service Any combination of SP3, SP9, SP35. 1 to 6 cables

Additional local Protection **Install Method 1, Figures 4 & 5**
FIREFLYMasticHP applied to the gap between service and FIREFLY FR Block.
Install Method 2, Figure 7
When services are located at the edge of the block, protection required as per described above and with additional FIREFLYMasticHP applied to gap between service and FIREFLY FR Block

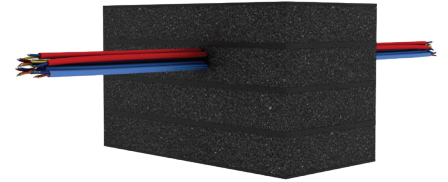

Part D | Service Penetration details, Plumbing & Hydraulics

Service ID **SP10**

Service 40 mm HDPE pipe, 1 pipe

Additional local Protection **Install Method 1, Figures 4 & 5**
10 mm fillet of FIREFLYMasticHP

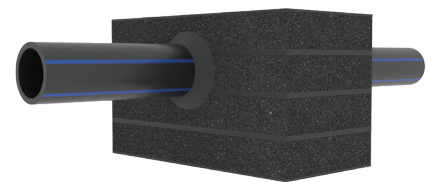

Service ID **SP11**

Service PEX pipes 16 mm x 2.2 mm to 32 mm x 4.4 mm, 1 pipe

Additional local Protection **Install Method 1, Figures 4 & 5**
None

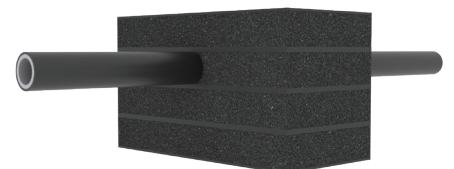

Service ID	SP12
Service	PEX AL pipe 16 mm x 2.2 mm, 1 pipe
Additional local Protection	Install Method 1, Figures 4 & 5 None

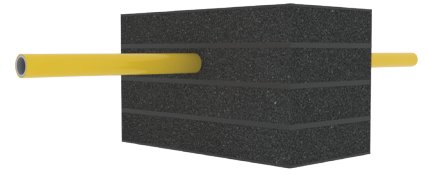

Service ID	SP13
Service	CPVC sprinkler pipe 34.4 mm up to 48 mm, 1 pipe
Additional local Protection	Install Method 1, Figures 4 & 5 Pipe to be wrapped locally with grease proof paper prior to installation into the FIREFLY FR Block

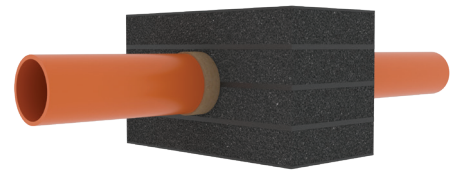

Service ID	SP17
Service	Galvanised steel pipes up to 50 mm OD



Install Method 1 | Figures 4 & 5

1. A small section of a single layer of intumescent strip can be locally cut out to allow for the steel pipe to be friction fitted through FIREFLY FR Block
2. Any gaps around the pipe are to be filled full depth of FIREFLY FR Block with FIREFLYMastic or FIREFLYMasticHP
3. An additional 25 mm fillet of FIREFLYMasticHP is to be applied around the face of the pipe and FIREFLY FR Block
4. A 100 mm wide FIREFLY Penowrap is then applied with min. 25 mm overlap and fixed into place with 2 x equally spaced stainless steel cable ties

Install Method 2 | Figures 4 & 5

1. A small section of a single layer of intumescent strip can be locally cut out to allow for the steel pipe to be friction fitted through FIREFLY FR Block
2. Any gaps around the pipe are to be filled full depth of FIREFLY FR Block with FIREFLYMastic or FIREFLYMasticHP
3. A 100 mm wide FIREFLY Penowrap is then applied with min. 25 mm overlap and fixed into place with 2 x equally spaced stainless steel cable ties

Install Method 3 | Figure 6

1. A small section of the corner of FIREFLY FR Block can be locally cut out to allow for the steel pipe to be friction fitted through FIREFLY FR Block
2. Any gaps around the pipe are to be filled full depth of FIREFLY FR Block with FIREFLYMastic or FIREFLYMasticHP
3. A 100 mm wide FIREFLY Penowrap is then applied with min. 25 mm overlap and fixed into place with 2 x equally spaced stainless steel cable ties

Service ID **SP18**
Service PVC Spigot & Ø16 mm PVC Flexi-drain pipe
Additional local Protection **Install Method 1, Figures 4 & 5**
 None

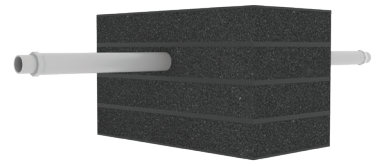

Service ID **SP20**
Service Hole repair up to 30 mm x 25 mm, FIREFLYMastic or FIREFLYMasticHP
Additional local Protection **Install Method 1, Figures 4 & 5**
 None
Install Method 2, Figure 7
 When services are located at the edge of the block, FIREFLYMasticHP should be applied to gap between the service and FIREFLY FR Block

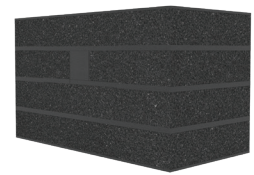

Service ID **SP21**
Service Double Armaflex lagged max. 19 mm copper pipes with Armaflex FRV 9 mm - wall lagging
Additional local Protection **Install Method 1, Figures 4 & 5**
 Full depth FIREFLYMasticHP between the 2 pipes

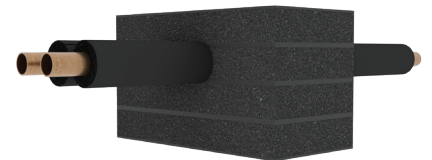

Service ID **SP22**
Service Single Armaflex lagged max. 19 mm copper pipe with Armaflex FRV 9 mm - wall lagging
Additional local Protection **Install Method 1, Figures 4 & 5**
 None

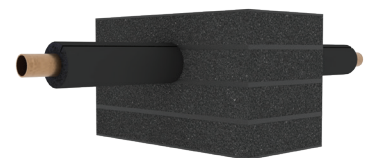

Service ID **SP23**
Service PVC pipes up to 50 mm
Additional local Protection **Install Method 1, Figures 4 & 5**
 None

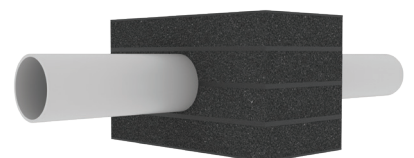

Service ID **SP24**

Service Up to 32 mm x 4.7 mm PE-X/AL/PE pipe

Additional local Protection **Install Method 1, Figures 4 & 5**
25 mm fillet of FIREFLYMasticHP

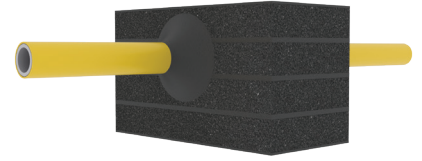

Service ID **SP34**

Service 2 x up to Ø20 mm PE-Xa pipes

Additional local Protection **Install Method 1, Figures 4 & 5**
FIREFLYMasticHP applied to gap between service and FIREFLY FR Block

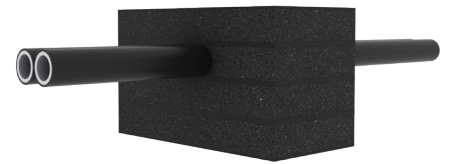

Part D | Service Penetration details, HVAC

Service ID **SP8**

Service A set of Pair Coil copper pipes in nitrile rubber insulation: ARDENT PR CU FR 13 mm 1/4" & 1/2" R410A (6.35 mm x 0.80 mm to 12.7 mm x 0.80 mm) **or** A set of 3/8" & 5/8" Pair Coil copper pipes in 8.9 mm thick and 7.8 mm thick ARDENT

Additional local Protection **Install Method 1, Figures 4 & 5**
Apply FIREFLYMasticHP to the full depth of FIREFLY FR Block between the 2 pipes



Service ID
SP19
Service

A set of copper Pair Coil of either -

- 1/4" & 1/2" R410A pair coil (6.35 mm x 0.80 mm to 12.7 mm x 0.80 mm) with 13 mm insulation ARDENT FR CU FR, **or**
- 3/8" & 5/8" FR Pair Coil with 19 mm insulation ARDENT Superpair FR, **or**
- 3/8 & 5/8" Pair Coil copper pipes in 8.9 mm and 7.8 mm thick ARDENT Cross-linked Polyethylene (CLPE) foam lagging, **and optionally**
- Up to 2 x 2.5 mm² 2C+E TPS cable
- 1 x 3C+E power cable (1.5 mm², 10 mm OD)

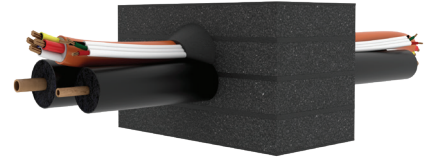
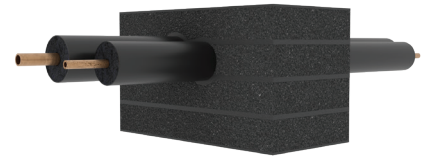
Install Method 1 | Pair Coils without cables in location as per Figures 4 & 5

1. A small section of a single layer of intumescent strip can be locally cut out to allow for the Pair Coil pipe to be friction fitted through FIREFLY FR Block
2. Any gaps around the service are to be filled full depth of FIREFLY FR Block with FIREFLYMasticHP

Install Method 2 | Pair Coils with TPS and/or power cables in location as per Figures 4, 5 & 6

1. A small section of a single layer of intumescent strip can be locally cut out to allow for the Pair Coil pipe to be friction fitted through FIREFLY FR Block
2. Any gaps around the service are to be filled full depth of FIREFLY FR Block with FIREFLYMasticHP
3. A 50 mm fillet of FIREFLYMasticHP is to then be applied over the cables at the service / FIREFLY FR Block interface